



# Over & Above.

The Brick Tile Cladding System.



**TAYLOR MAXWELL**



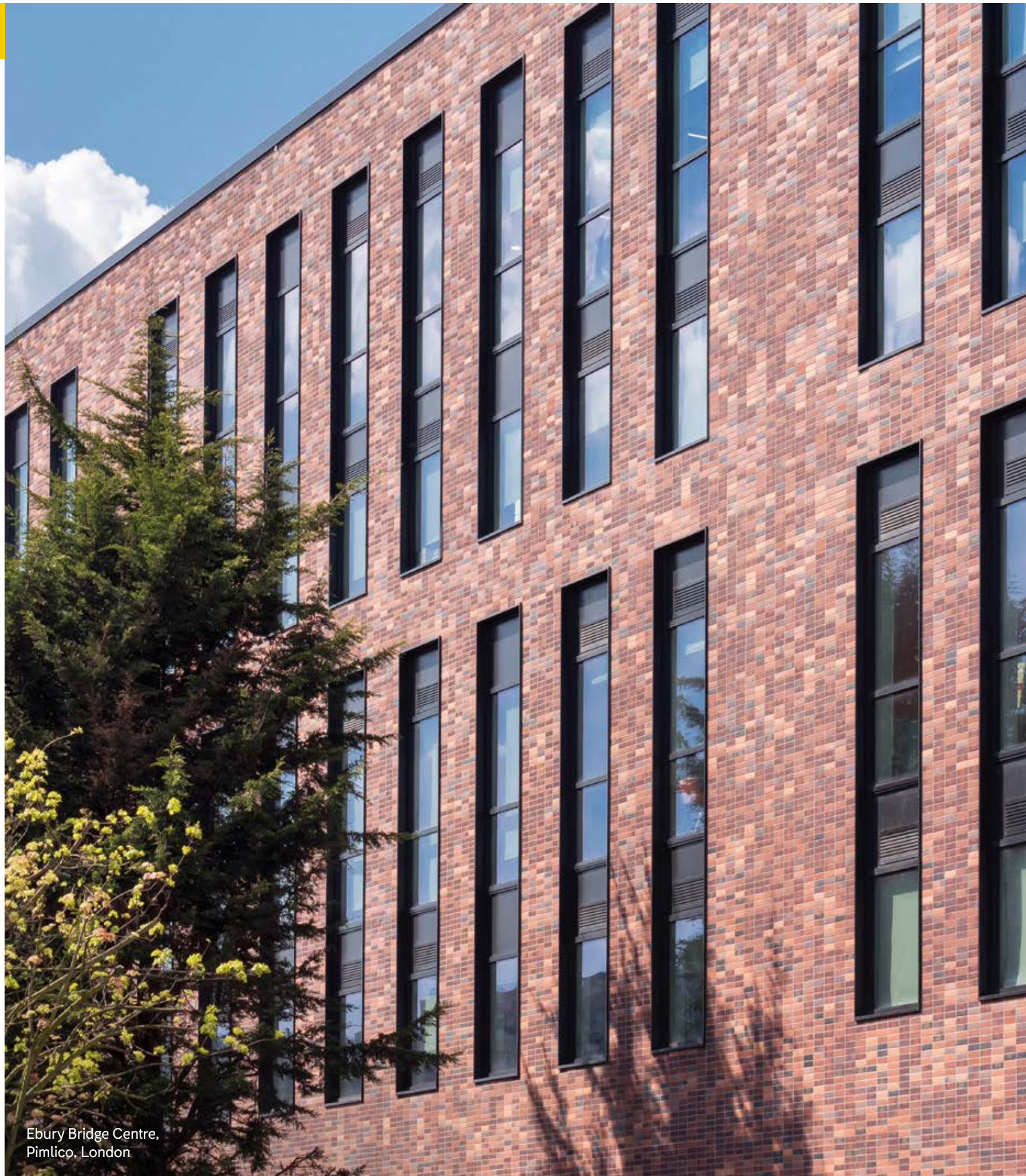

Ebury Bridge Centre,  
Pimlico, London

# Over & Above

Because higher standards  
are our standard.



## Contents

A Trusted Partnership	04-05
What is Corium?	06-09
The Print Hall Case Study	10
The Ritterman Building Case Study	11
Over & Above on Performance	12-13
295 Holloway Road Case Study	14-15
Over & Above on Safety	16-17
Over & Above on Flexibility	18-19
Installation Detail	20-21
Tiles	22-23
Specials, Mortar & Movement Joints	24-25
Curves, Soffits & Off-site Assembly	26-27
Over & Above on Aesthetics	28-29
Cambridge Mosque Case Study	30-31
Colour Range	32-33
Brick Textures	34-35
Use & Installation	36-37



# A Trusted Partnership

Delivering higher standards is a commitment shared by Wienerberger and Taylor Maxwell, and it's one that's defined a decade-long partnership. For 10 years, Corium has led the way in safety standards, durability, and flexibility. The product is fully BBA certified and, as per section 7.1 of that document, all system components are Class A1, as defined by national Building Regulations.

Corium is a unique brick cladding system that combines the natural beauty of brick, with effective fast-track installation. The system is produced by Wienerberger, the UK's leading provider of wall, roof and landscape innovations. With 200 years of heritage in the industry, Wienerberger has been trusted by generations to provide quality solutions that stand the test of time. Taylor Maxwell is the exclusive distributor of Corium, and has been supplying a range of external façade solutions to the UK construction industry since 1959, with a reputation for integrity and service that puts the customer front and centre.

A market-leading partnership that goes over and above on expertise, with a wealth of knowledge and skills supporting the Corium system across both businesses. Trust built over a decade, and solutions that stand the test of time.



TAYLOR MAXWELL

South Thames College,  
Welbeck House, London

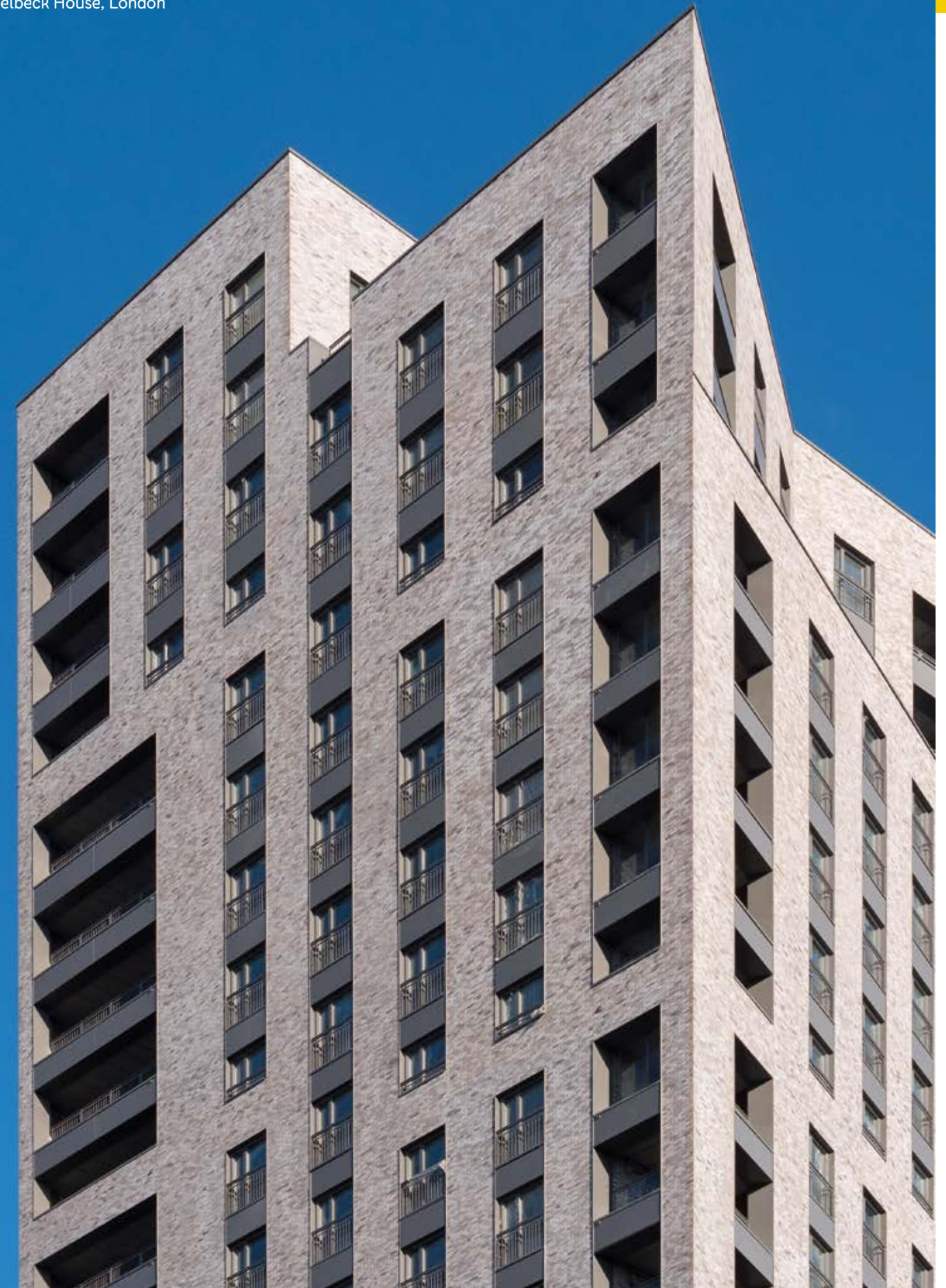



# What is Corium?







Central Square,  
Leeds

We've gone over and above to create a best-in-class brick tile cladding system for the built environment. The system comprises of clay brick tiles, clipped into interlocking steel backing sections mounted horizontally or vertically. It is suitable for use on steel framed substrate walls, external masonry and timber frame of both new and existing buildings.

**Corium is backed by full BBA and fire testing certification. All designed to deliver safety, flexibility and performance.**



### Safety.

- ✓ BBA approved and certified(19/5693)
- ✓ Fire tested and approved, in accordance with EN 13501-1: 2007 + A1:2009
- ✓ In the opinion of the BBA (page 3 of the certificate), Corium can satisfy or contribute to satisfying the relevant requirements in relation to NHBC standards

### Design Flexibility.

- ✓ Over 2,500 brick tile finishes available, including choices of colour and texture
- ✓ The option to develop bespoke blends for projects
- ✓ Variable tile height options of 50mm, 65mm, 140mm and 215mm
- ✓ Can be installed horizontally or vertically, including soffits and ceilings

### Performance.

- ✓ A design life in excess of 35 years in accordance with section 10 of the BBA certificate
- ✓ No build limit, with installations on projects in the UK up to 28 storeys (as per section 6.2 of the BBA certificate)\*
- ✓ Simple mechanical fix installation

\*Design wind actions must be calculated in accordance with BS EN 1991-1-4 : 2005 and its UK National Annex. Due consideration should be given to higher pressure coefficients applicable to corners of the building, as recommended in this Standard. In accordance with BS EN 1990 : 2002, it is recommended that a partial load factor of 1.5 is applied to determine the design wind load to be resisted by the system. Please see the BBA certificate for full information.



PROJECT NAME

# The Print Hall

LOCATION  
Bristol, UK

MAIN CONTRACTOR  
Midas

INSTALLER  
CCS Façades

ARCHITECT  
Russ Drage Architects

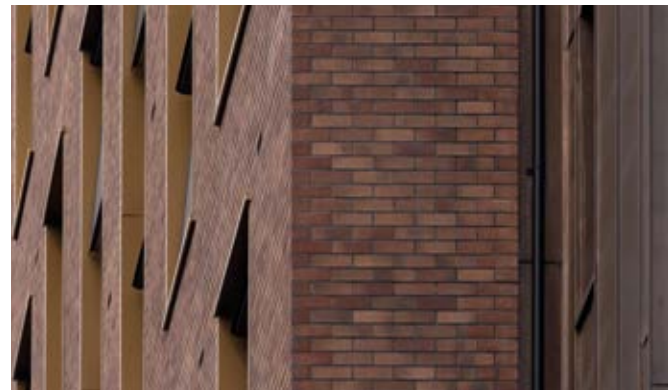
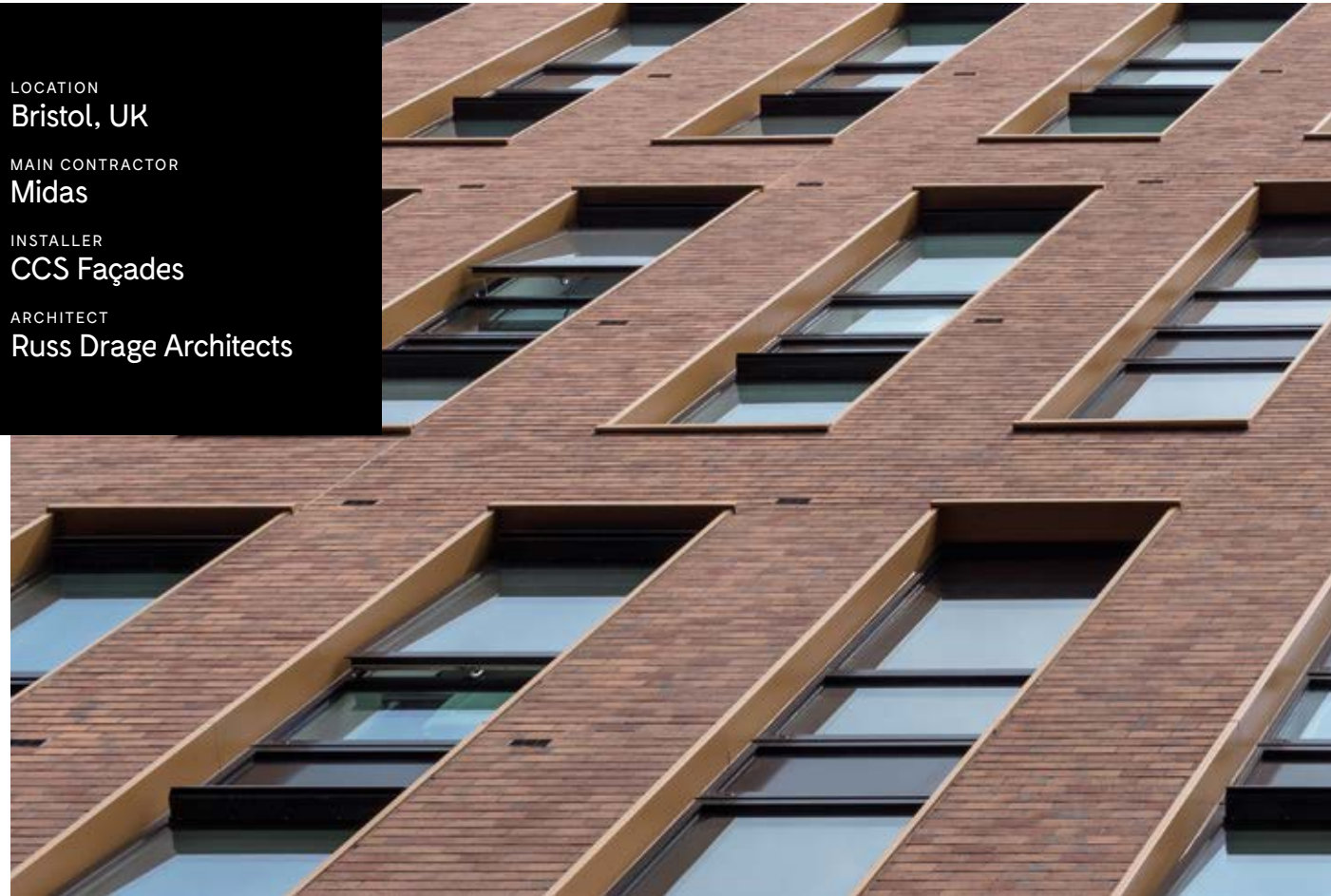

PROJECT NAME

# The Ritterman Building

LOCATION  
Middlesex University,  
Hendon

MAIN CONTRACTOR  
Interserve

INSTALLER  
Domus Façades

ARCHITECT  
BPR Architects

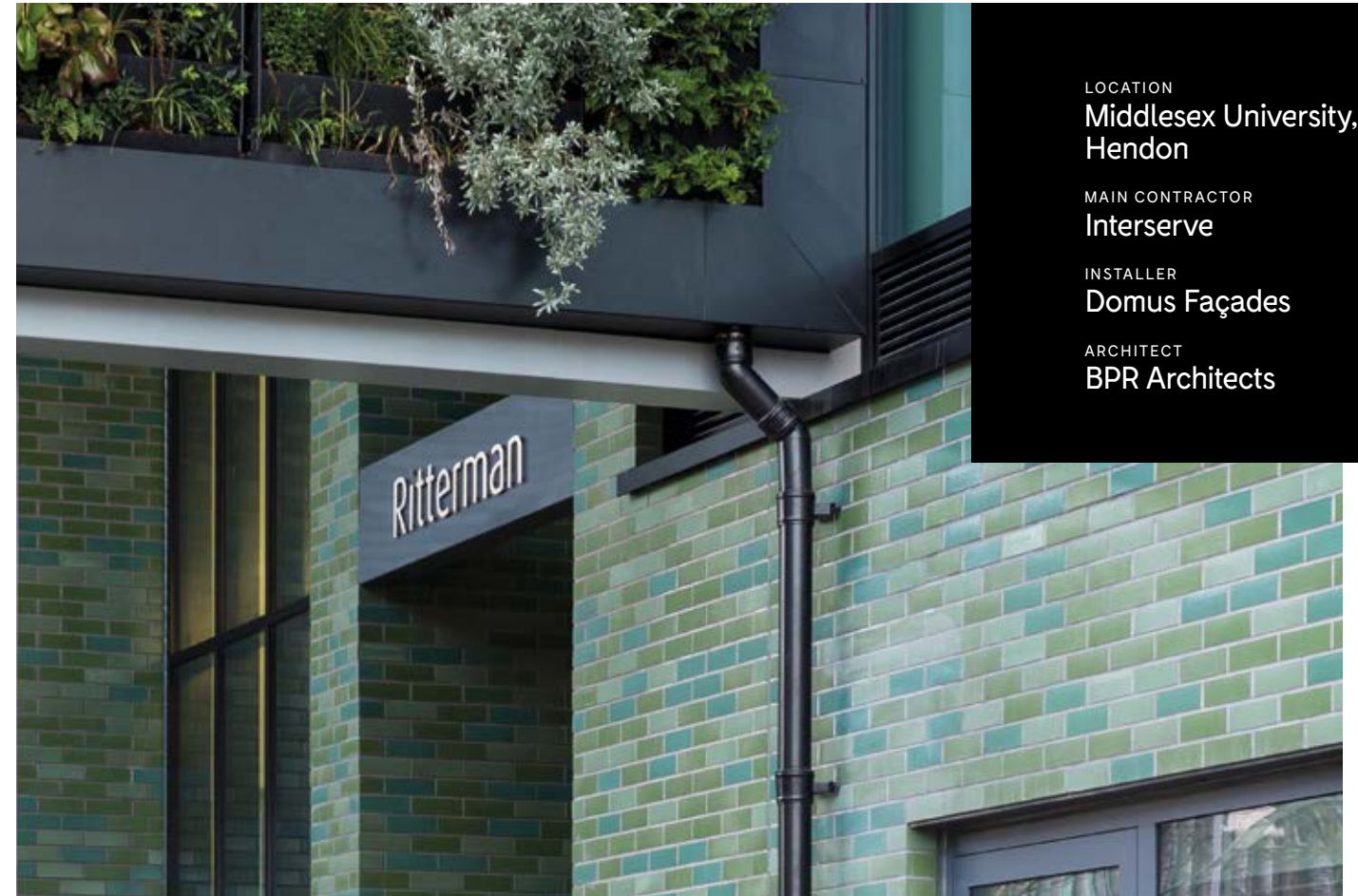

3  
shades of  
green glazed  
Corium tiles

£18m  
project



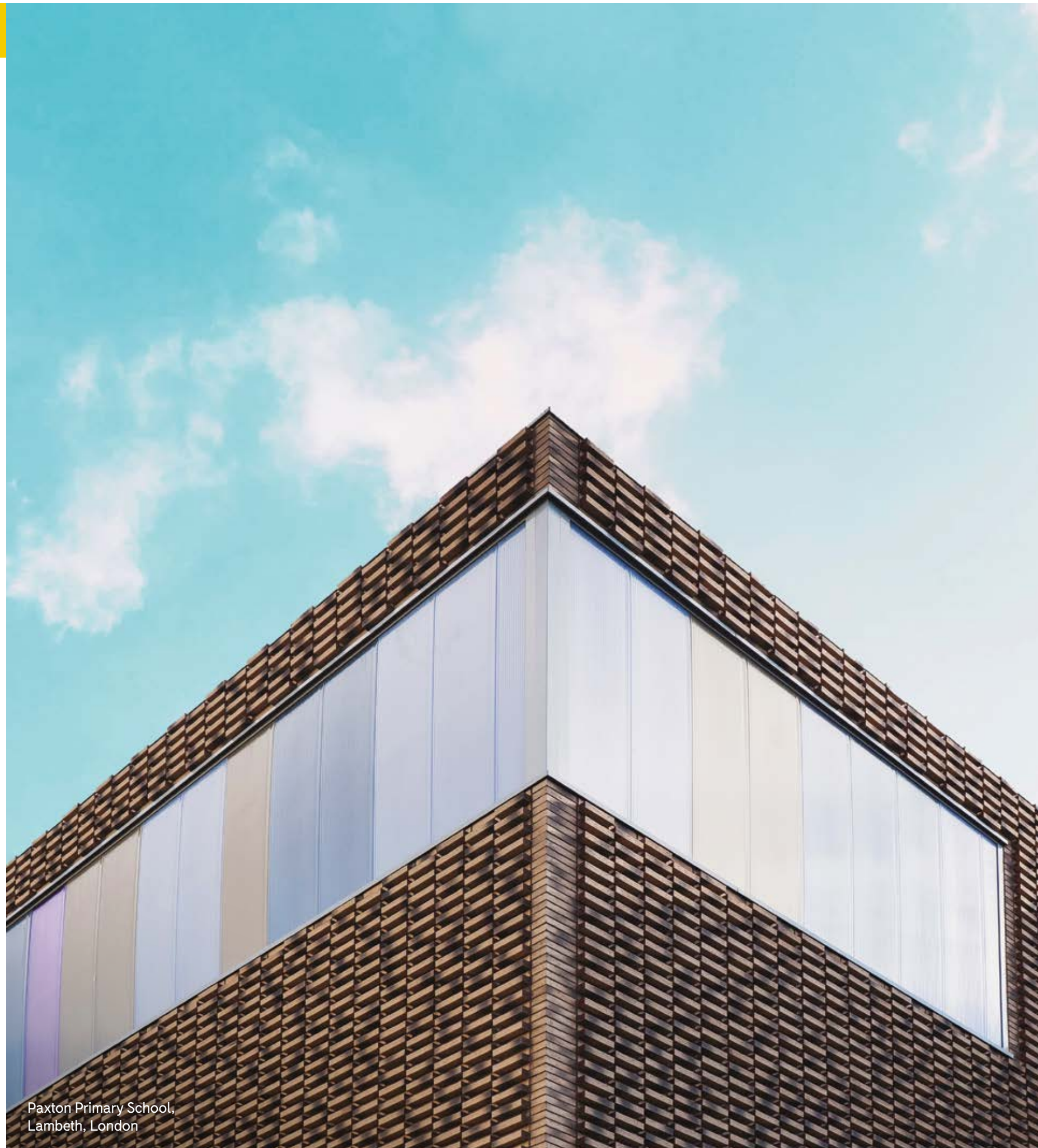

Paxton Primary School,  
Lambeth, London

# Over & Above on Performance.

We've gone over and above to make sure Corium provides exceptional performance. The system is fully BBA certified, so you can rest assured that Corium will meet the needs of your project.

## ✓ Strength & Stability

The system can be designed to resist wind actions normally encountered in the UK (as per section 6 of the BBA certificate).

## ✓ Fire Resistance

The system components are Class A1 as defined in the national Building Regulations (as per section 7 of the BBA certificate).

## ✓ Wind & Water Resistance

The system minimises water penetration and the risk of damage to the inner wall (as per section 8 of the BBA certificate).

## ✓ Durability

When used in normal exposure conditions, the system can have a design life in excess of 35 years (as per section 10 of the BBA certificate).

## ✓ Building at Height

No build limit, proven to be built to 28 storeys (as per section 6.2 of the BBA certificate)\*.

\*Design wind actions must be calculated in accordance with BS EN 1991-1-4 : 2005 and its UK National Annex. Due consideration should be given to higher pressure coefficients applicable to corners of the building, as recommended in this Standard. In accordance with BS EN 1990 : 2002, it is recommended that a partial load factor of 1.5 is applied to determine the design wind load to be resisted by the system. Please see the BBA certificate for full information.



PROJECT NAME

# 295 Holloway Road

LOCATION

London, UK

MAIN CONTRACTOR

Tide Construction

INSTALLER

Century Façades

ARCHITECTS

HTA Design



## 13 storey



### Curved soffit





# Over & Above on Safety.

Because higher standards are our standard, we've made sure Corium meets rigorous safety criteria. All the certification and reassurance you need to feel confident in Corium.

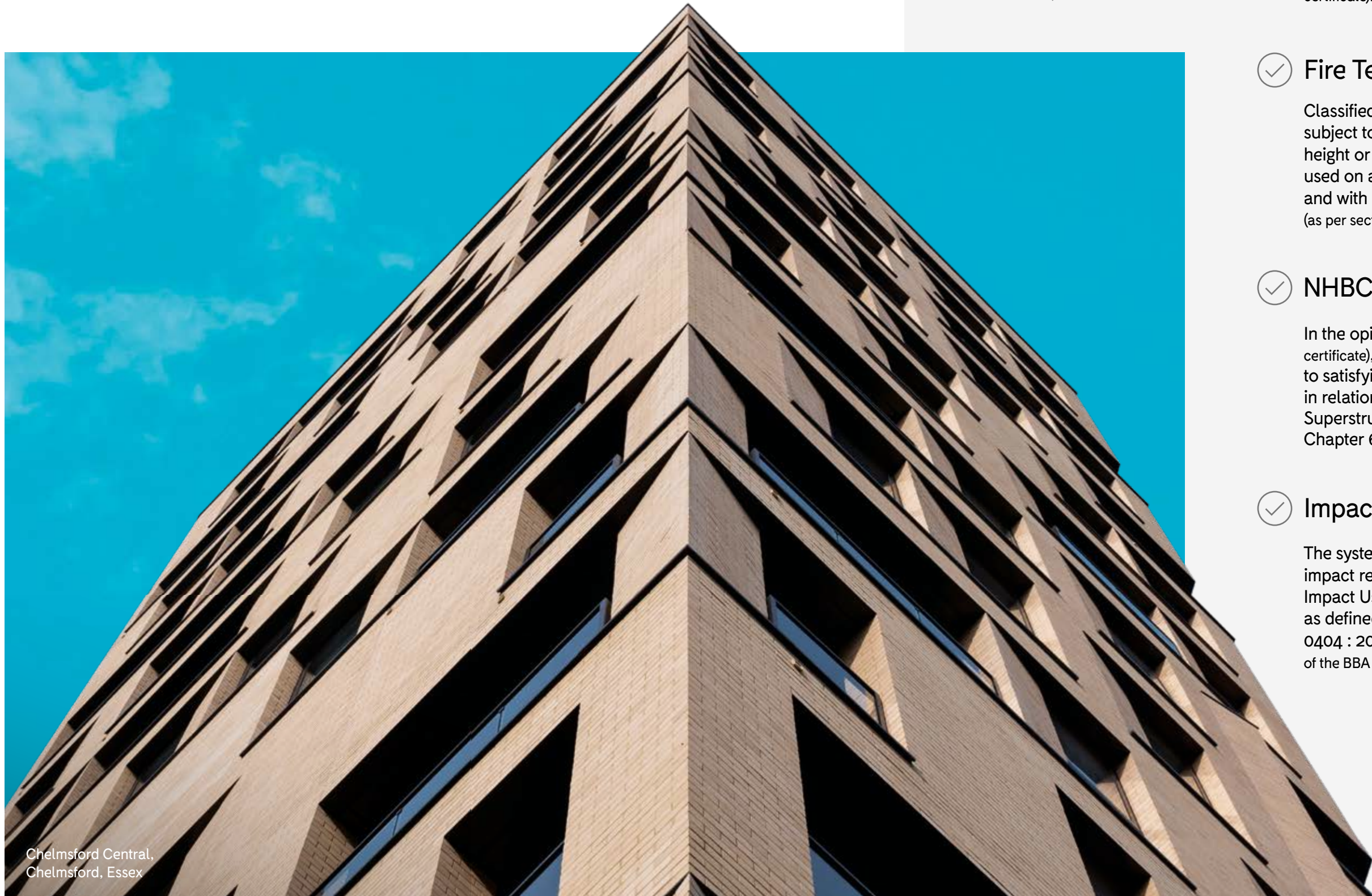

Chelmsford Central,  
Chelmsford, Essex



## ✓ BBA Certified

Certified for use as protective/ decorative cladding over external masonry, timber or steel-frame substrate walls of new and existing buildings (as per page 1 of the BBA certificate).

## ✓ Fire Tested & Certified

Classified as 'non-combustible' and not subject to any restriction on building height or proximity to boundary when used on a non-combustible substrate and with non-combustible components (as per section 7.2 of the BBA certificate).

## ✓ NHBC Standards

In the opinion of the BBA (page 3 of the certificate), Corium can satisfy or contribute to satisfying the relevant requirements in relation to NHBC standards, Part 6 Superstructure (excluding roofs) and Chapter 6.9 Curtain walling and cladding.

## ✓ Impact Tested

The system achieved adequate impact resistance for use in the Impact Use Categories II, III and IV, as defined by EAD 090062-00-0404 : 2018, table G.3 (as per page 8 of the BBA certificate).



# Over & Above on Flexibility.

Corium is a system designed for adaptability and performance. The system comprises of fired clay extruded brick tiles, which are clipped into longitudinally interlocking steel backing sections. The vertical and horizontal joints between the tiles are pointed with Parex Historic Mortar KL.

The steel backing sections are profiled to suit the brickwork coursing height, mounted horizontally or vertically and then mechanically fixed to the supporting subframe. For lightweight steel frame and masonry substrates, the subframe is generally aluminium, but for timber-frame structures this would be timber battens.



Typical fixing pattern of the Corium Brick Tile Cladding System

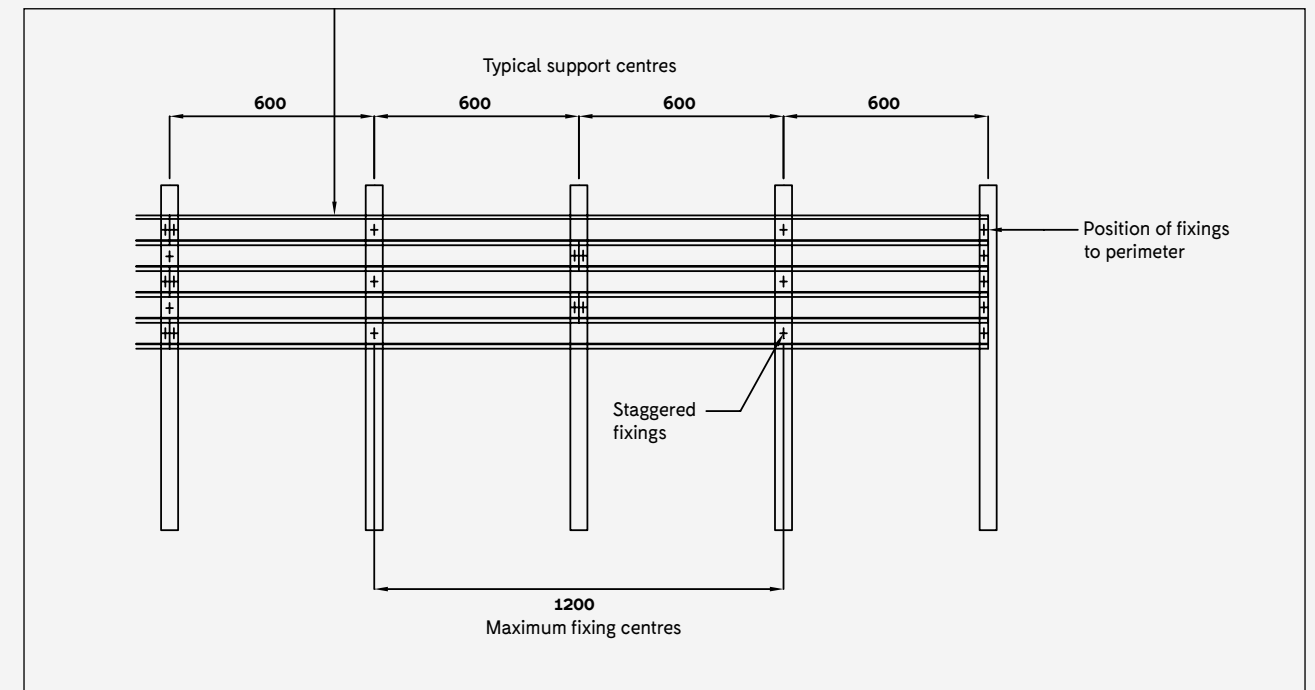

Corium Tile & Steel Backing Profile (Dimensions in mm)

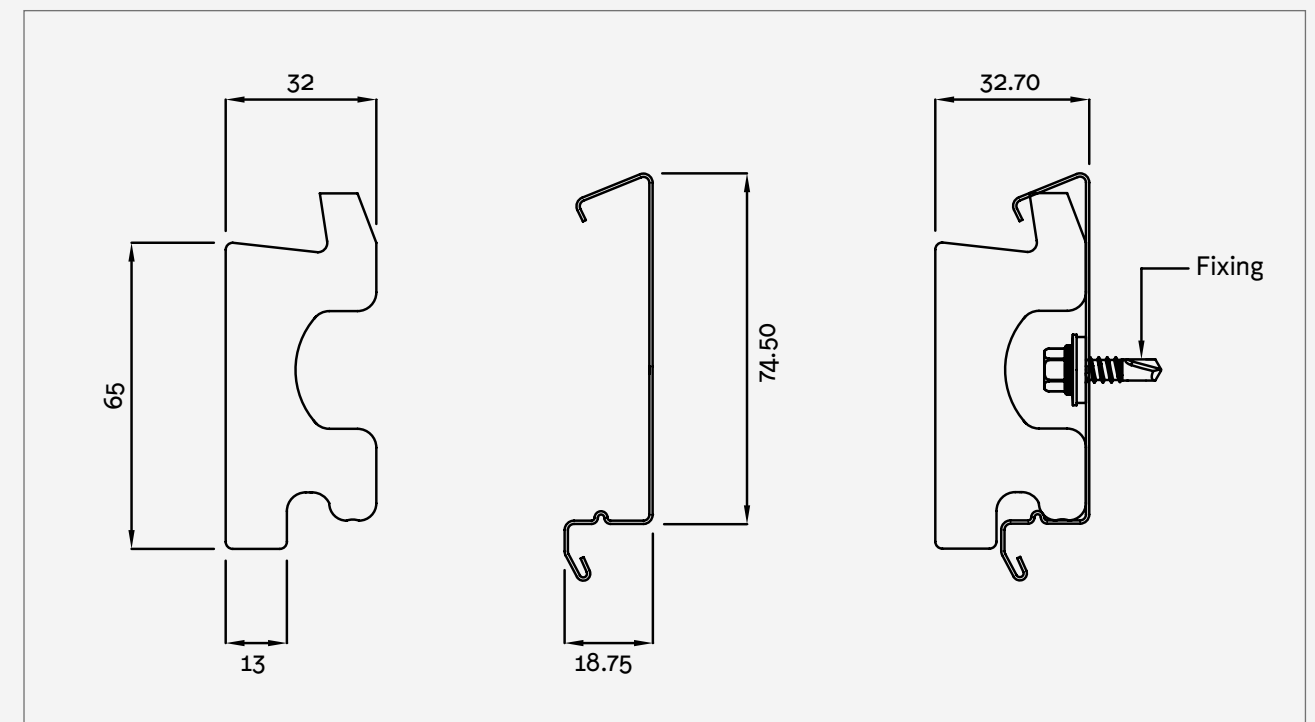



# Installation detail of the Corium Brick Tile Cladding System.

## Timber Frame

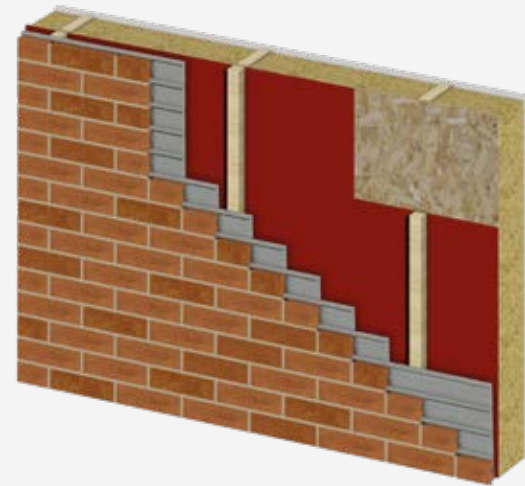
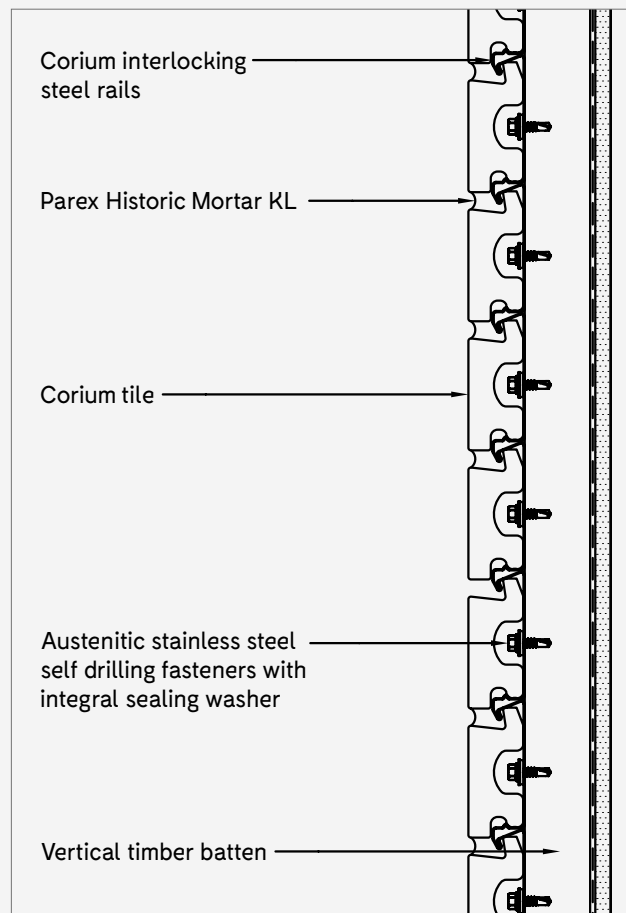

## Lightweight Steel Frame

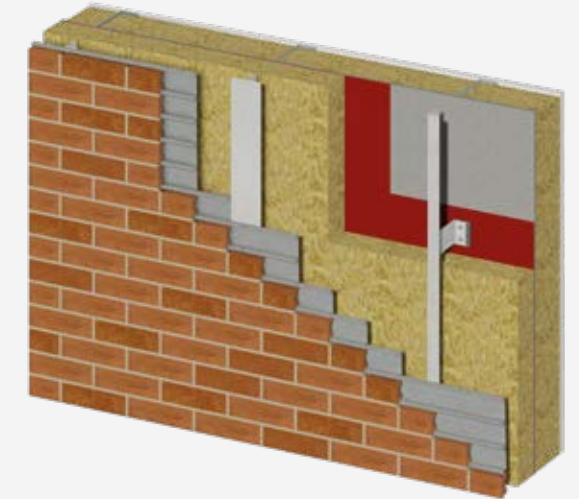
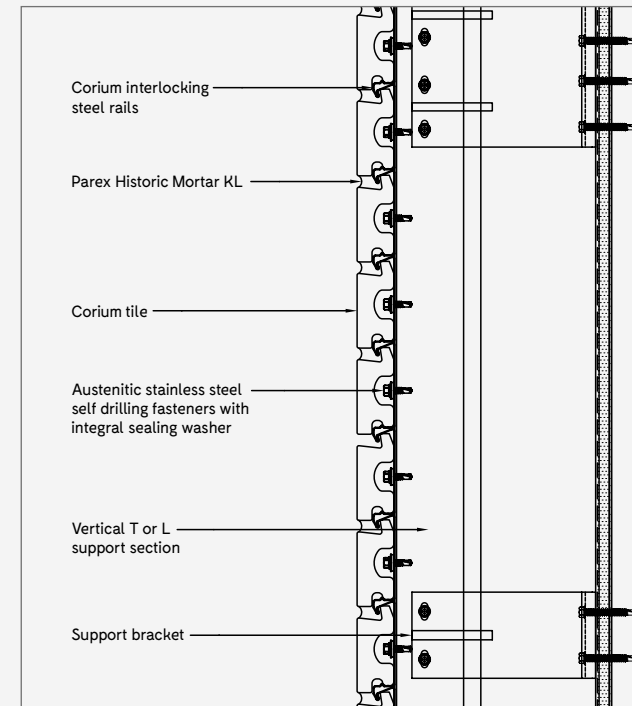

## Lightweight Steel Frame - Vertical

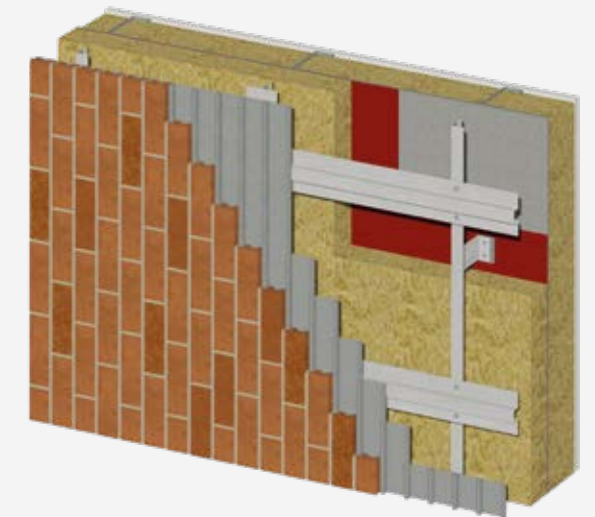
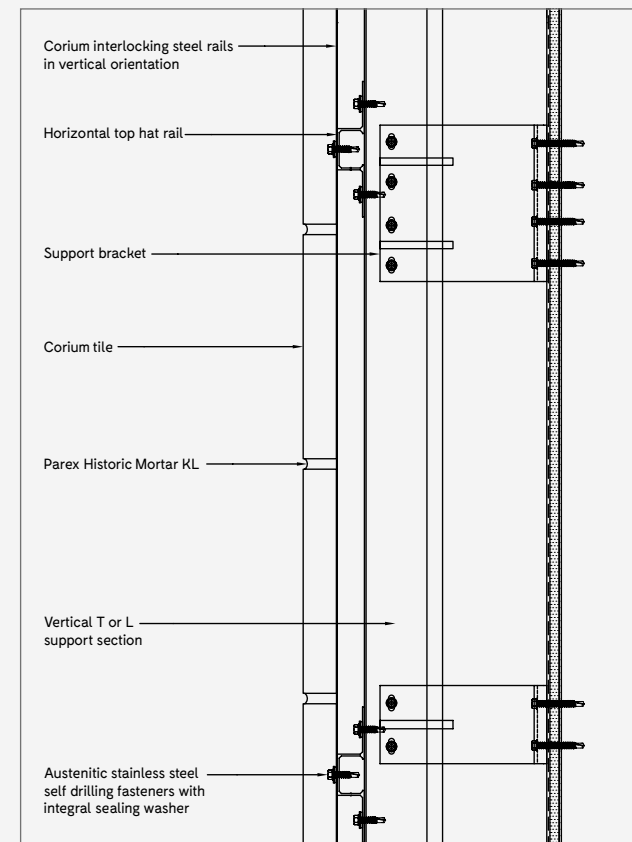



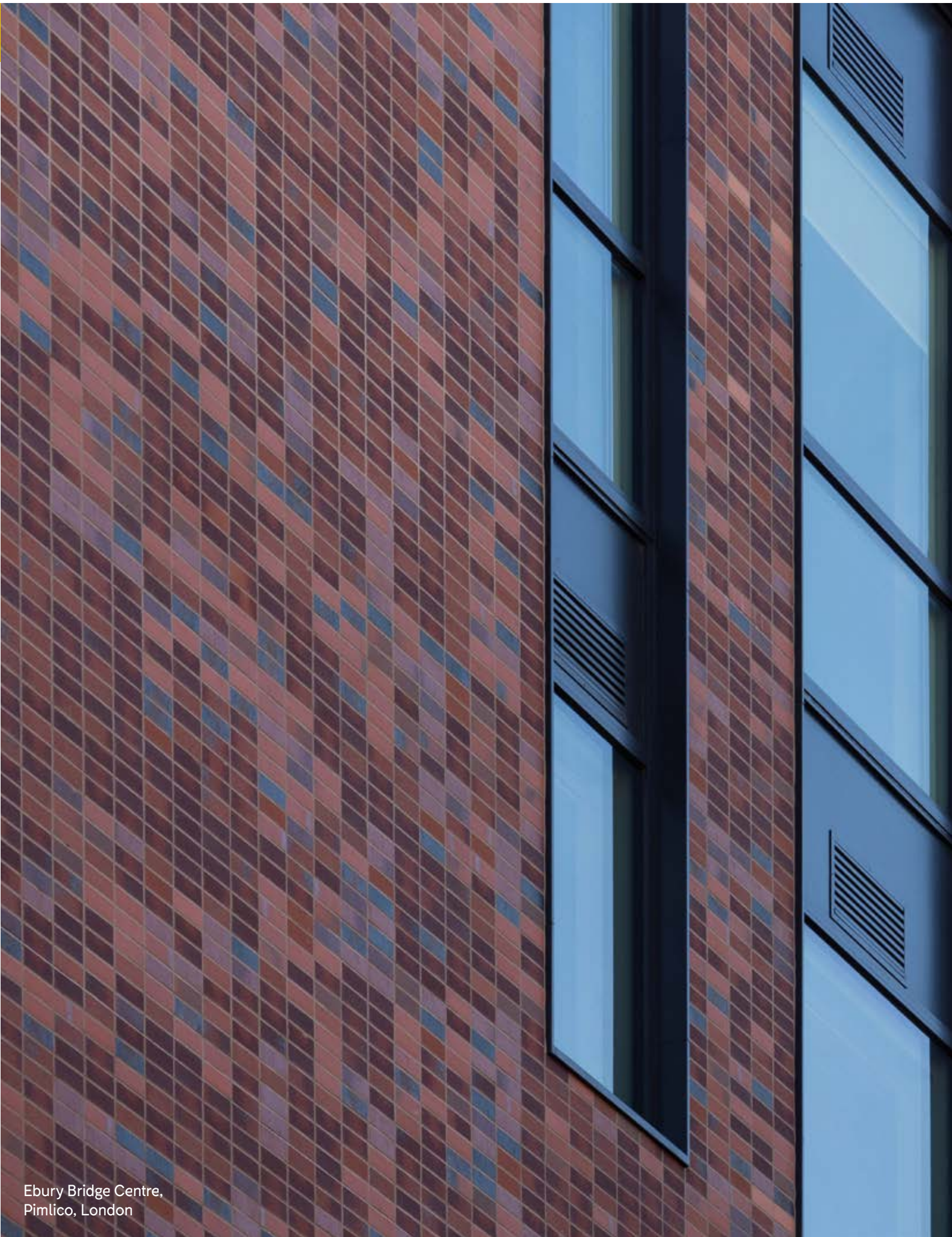

Ebury Bridge Centre,  
Pimlico, London

# Tiles

The fired clay tiles extruded brick tiles are manufactured to a range of dimensions, allowing for aesthetic choice and flexibility. Though outside BBA certification, we can also produce other lengths for projects that need something bespoke. Tiles are available in a range of colours, presenting a large number of aesthetic combinations.

HEIGHT (mm)  
**50, 65, 140, 215**

LENGTH (mm)  
**215**  
(OTHER LENGTHS AVAILABLE UP TO 327mm)

THICKNESS (mm)  
**32, 80\***

TILE LIP THICKNESS (mm)  
**13**

\*CWCT tested but not included in the BBA.



# Specials

The system is designed with flexibility in mind, so corners are no obstacle. A one piece external return tile (215 x 102mm) is available, or tiles can be cut and bonded on site or at one of our trusted fabricators.



# Movement Joints

To allow for horizontal movement, vertical expansion joints should be provided through tile, mortar and steel backing sections at a maximum of 12m centres in the brick tile cladding. Horizontal expansion joints to allow for vertical movement should be provided at maximum 9m centres. Joints should coincide with movement joints in the substrate wall and allow for the same degree of movement (see section 4.7 of the BBA Certificate).

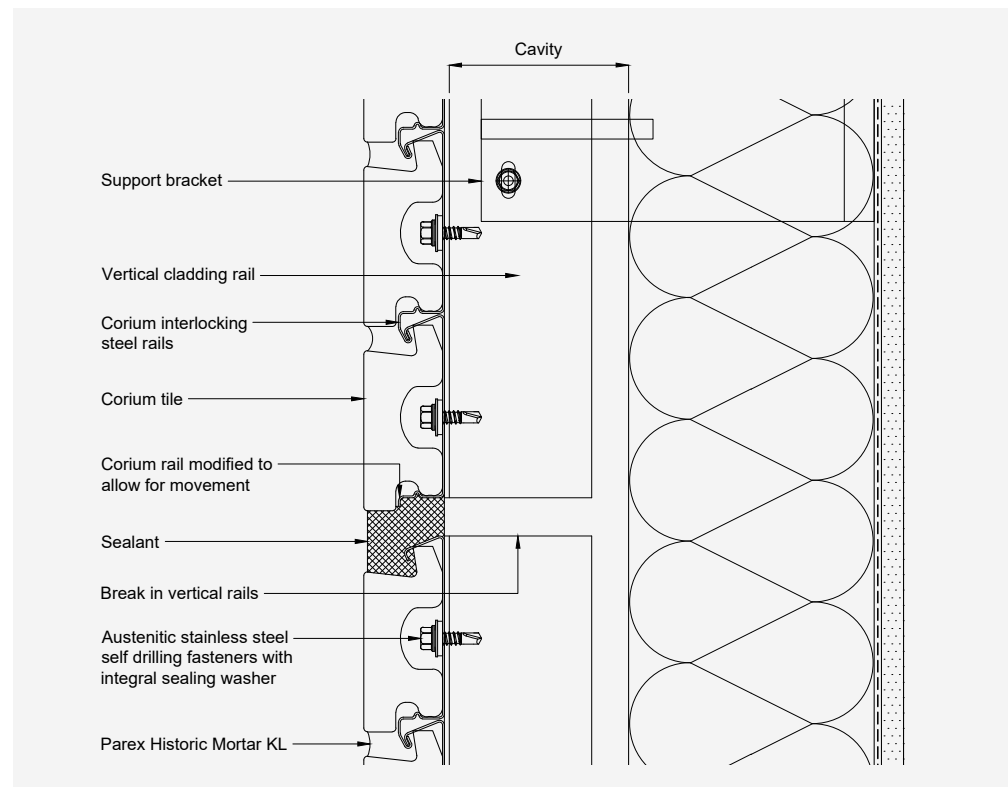

This information is for reference only and should not be regarded as a substitute for the role carried out by the architect or structural engineer. All design and installation with Corium should be in accordance with British and European Standards, Codes of Practice, building regulations and ancillary component manufacturers' guidance.

# Mortar

Joints between the tiles are pointed with Parex Historic Mortar KL, which is a hydrated lime, sand and ground granulated blast furnace slag (GGBS) mortar manufactured to BS EN 998-2 : 2016. The mortar is applied using manual, mechanical or compressed air based pumps with controlled nozzle applicators. The preferred joint profile is bucket-handle.

## Parex Mortar Colours

	SANDSTONE
	NATURAL
	MID BROWN
	LIGHT GREY
	MID GREY
	DARK GREY
	BATHSTONE
	BRICK RED
	LIGHT BROWN
	DARK BROWN
	DARK RED
	CHARCOAL
	STONE GREY
	TERRACOTTA
	PORTLAND



# Curves, Horizontal & Vertical Fitting

The system can be installed horizontally, vertically, or even at an angle, with no impact on performance, safety or durability (as per page 1 of the BBA certificate). This unlocks a wider range of aesthetic options as the system allows any brick bond pattern to be used.

Arches and curves are also achievable using Corium. Curves with a radius over 2m can be achieved easily, smaller radii can be achieved by cutting rails into shorter sections or installing the system vertically. Contact [corium@taylor.maxwell.co.uk](mailto:corium@taylor.maxwell.co.uk) for further information on how this can be achieved.



West Drayton, London

# Soffits

With both horizontal and vertical installations supported, as per page 1 of the BBA Certificate, Corium can be used overhead to create soffits and ceilings. A common feature found across both refurbishment and contemporary schemes.



295 Holloway Road, London

# Off-Site Assembly

If projects require it, Corium can be assembled off-site, allowing for finished sections to be installed as a pre-fabricated solution to be pointed on site.

This method not only ensures quality controlled factory conditions during fabrication, but it allows for rapid construction without delays due to weather, reducing wastage and on-site construction time.



Central Square, Leeds

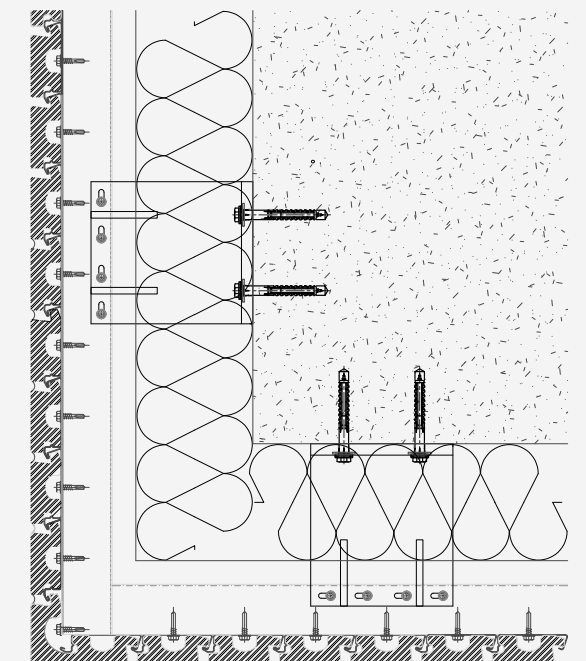



# Over & Above on Aesthetics.

Corium is a system with safety and performance at its heart, but it's also a system designed to provide impactful aesthetic results. For architects and specifiers, the wide range of tile colour choices enables a huge variety of combinations and visual approaches.

From traditional brick blends, to striking contemporary colour combinations, Corium has been designed to suit a wide range of aesthetic requirements.

- ✔ Choose from over 2,500 colours
- ✔ Finished textures include wirecut and simulated stock brick, dragface, sanded and smooth, multis, or matte and gloss glazes
- ✔ Bespoke options available on request
- ✔ Create blends for aesthetic effect

Contact us for more information on colour options, or to discuss your project needs [taylormaxwell.co.uk/corium](http://taylormaxwell.co.uk/corium)



Chelmsford Central,  
Chelmsford, Essex



PROJECT NAME

# Cambridge Mosque

LOCATION  
Cambridge, UK

MAIN CONTRACTOR  
M Clarke & Sons

ARCHITECTS  
Marks Barfield

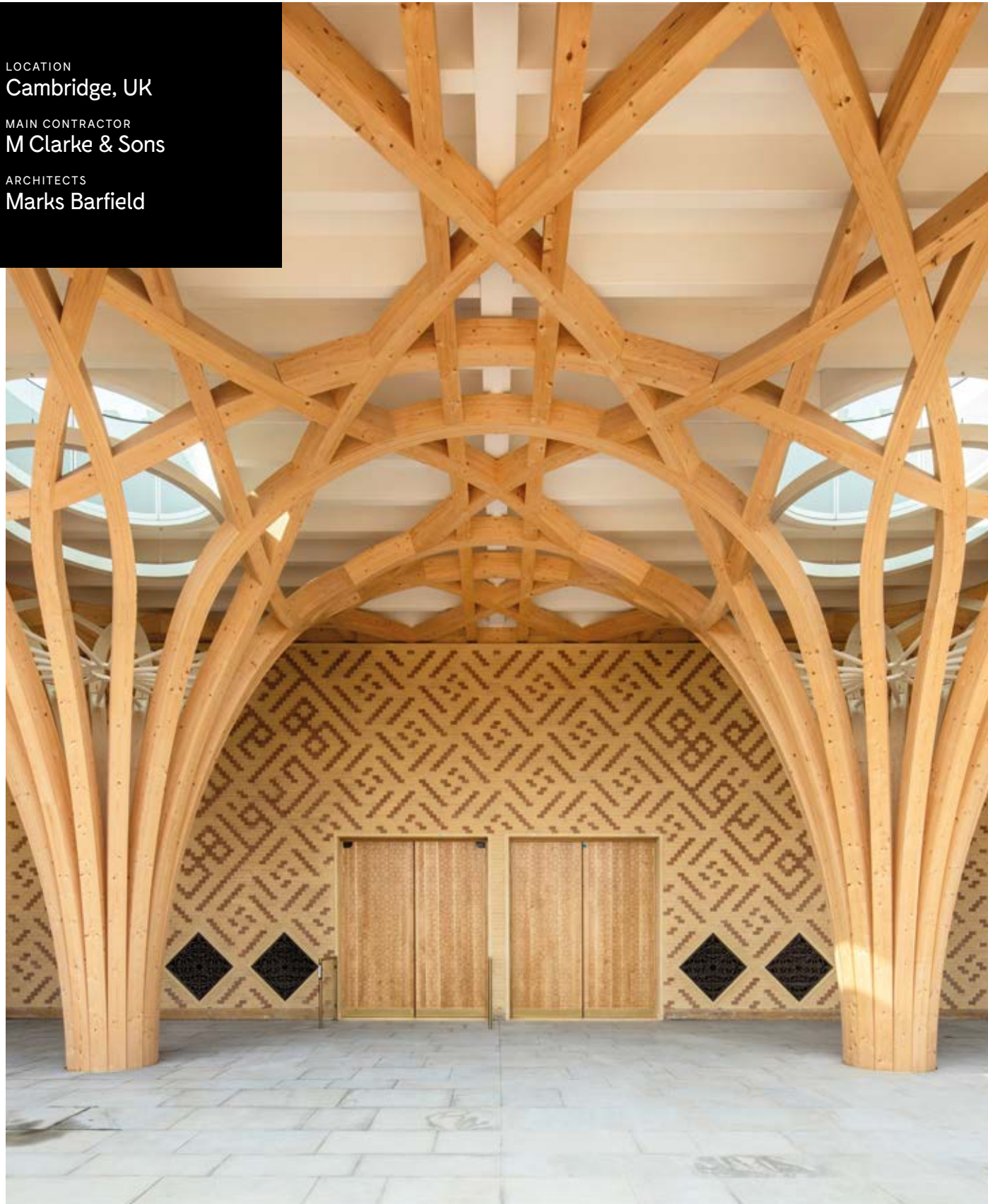

£23m project



2,305m<sup>2</sup>  
Corium supplied

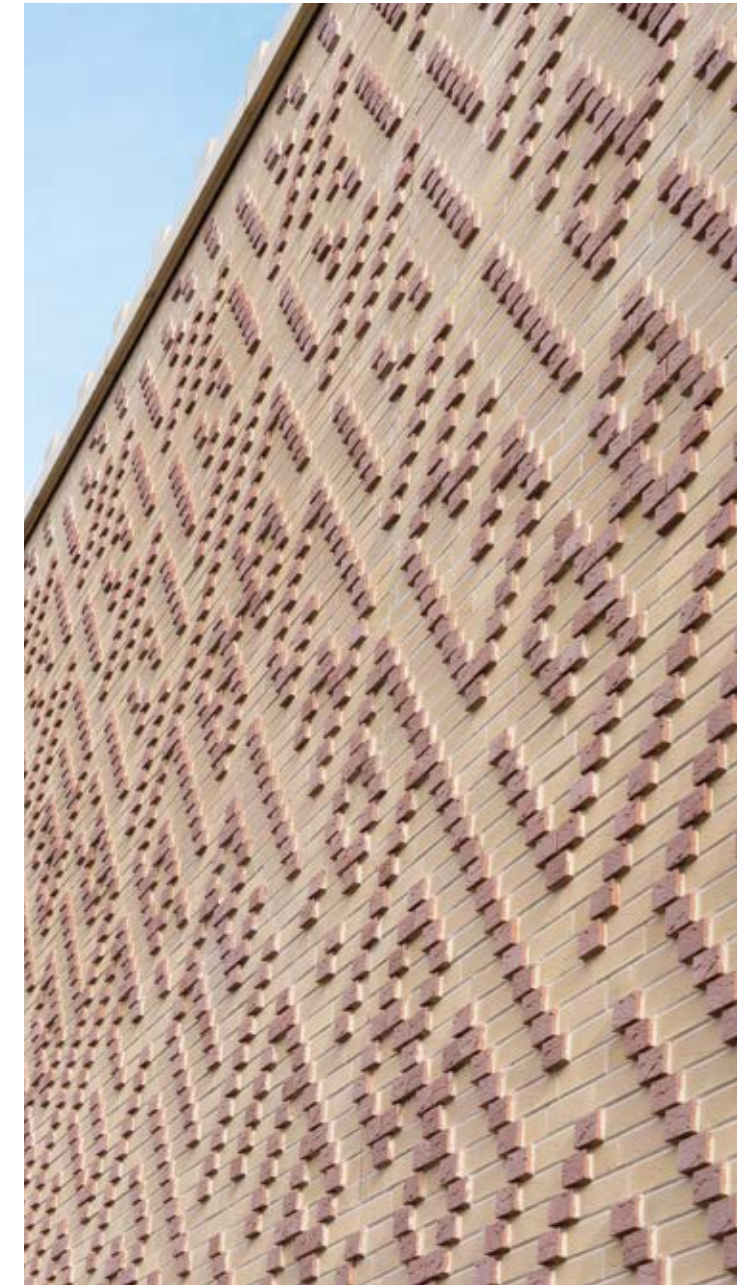



# Colour Range



The Ritterman Building,  
Middlesex University, Hendon

We have an extensive range of colours available, to view some of our options visit: [taylormaxwell.co.uk/corium](http://taylormaxwell.co.uk/corium)



Our extensive range of colours enables true aesthetic choice for your project. Traditional or contemporary, eclectic or uniform, there's a colour or blend to suit. Choose from a wide variety of standard colours, or get in touch to discuss how a bespoke blend could help make Corium the right choice for your scheme.

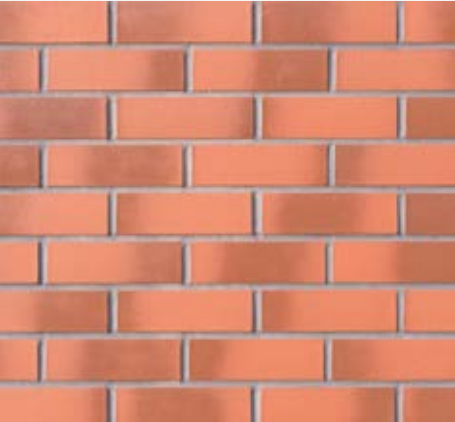



# Brick Textures

We've gone over and above on aesthetic choice, with a range of textures and finishes available to suit any scheme or style. From the nuanced feel of traditional brick, to smooth, contemporary glazed tiles, Corium is there to define the look and feel of your building.

Every project requires a different aesthetic. Get in touch to discuss the textures and finishes we offer.



Smooth



Sanded with Crease

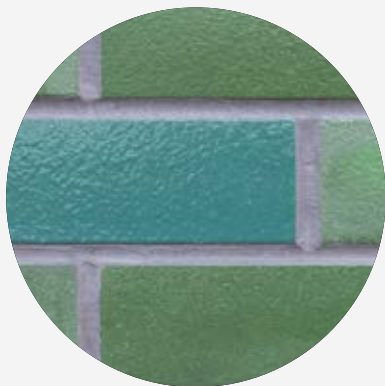

Gloss Glazed



Dragface without Crease



Dragface with Crease



Handformed Creased



Rustic Edges

We have a wide range of textures available, to view the full collection visit: [taylormaxwell.co.uk/corium](http://taylormaxwell.co.uk/corium)

Chelmsford Central,  
Chelmsford, Essex





# Use & Installation

Corium is a system designed for ease of use, with safe and speedy installation. A nationwide network of recognised installers install the system from mobile platforms, scissor lifts, mast climber or traditional scaffolding.

The procedure for installation (as per section 13 of the BBA certificate) provides a simple, quick and efficient way to create a weather-tight surface, allowing further construction to continue promptly. There's also the option to pre-fabricate sections in a quality controlled factory environment, speeding up installation further. Plus, it can be used anywhere above the damp-proof course level (as per section 4 of the BBA certificate).



**1**  
**Over & Above on Strength.**  
Rows of interlocking profiled steel sections are fixed to the backing structure.



**2**  
**Over & Above on Speed.**  
Brick tiles are then clipped into place. The clipping process ensures that consistent horizontal joints are achieved, whilst vertical joint spacing can be adjusted to suit design requirements.



**3**  
**Over & Above on Simplicity.**  
Once tiles are installed and quality approved, mortar is applied using a pump system, developed specifically to suit the characteristics of the tiles.

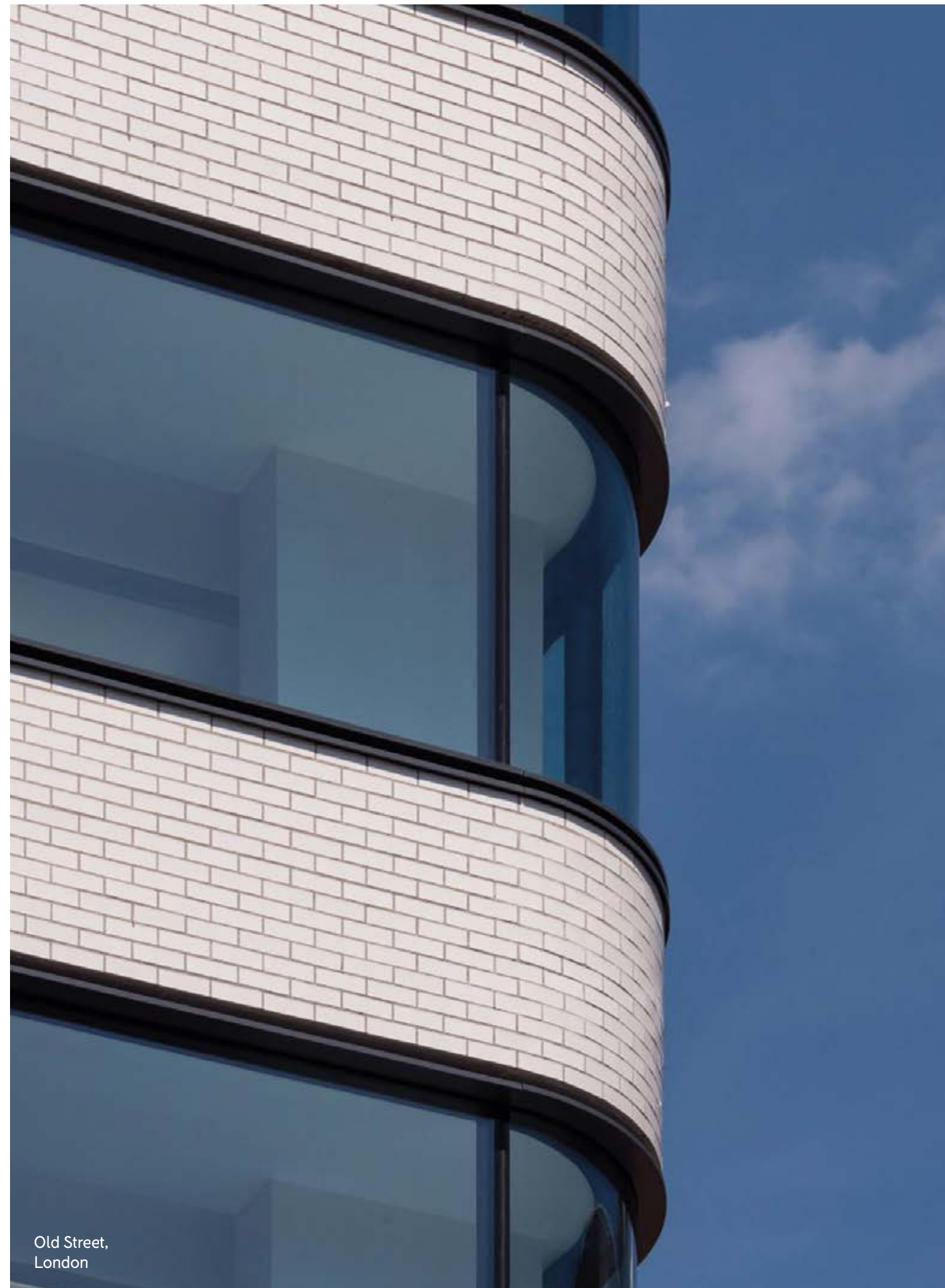

Old Street,  
London



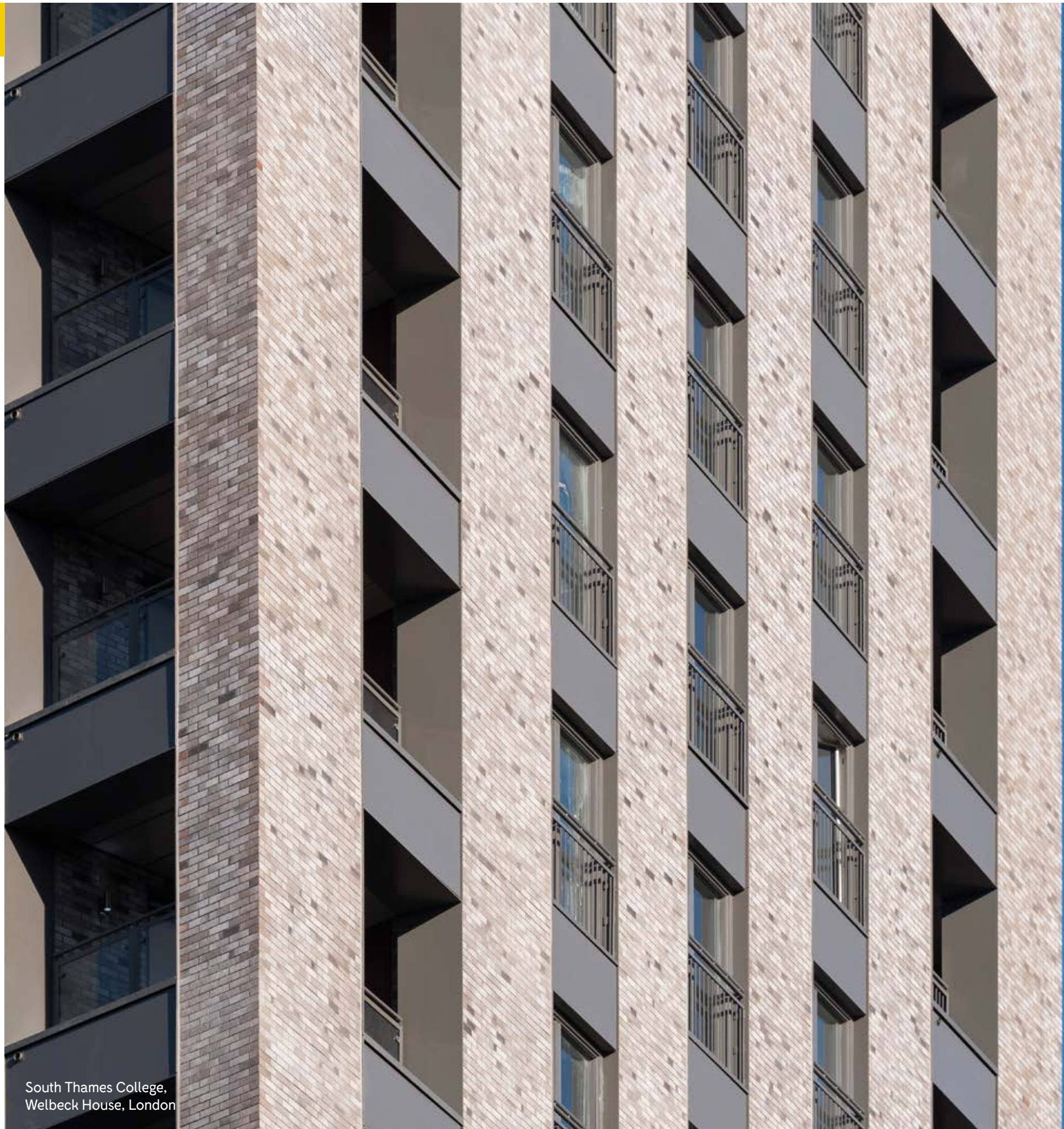

South Thames College,  
Welbeck House, London

# Because higher standards are our standards.

## Contact us

If you are interested in finding out more about our Brick Tile Cladding System, and how it might work with your project, contact us on **0203 7949377** or **corium@taylor.maxwell.co.uk**





Scan for full BBA

## Contact us

0203 794 9377

[corium@taylor.maxwell.co.uk](mailto:corium@taylor.maxwell.co.uk)

Taylor Maxwell House

The Promenade, Clifton, Bristol, BS8 3NW